

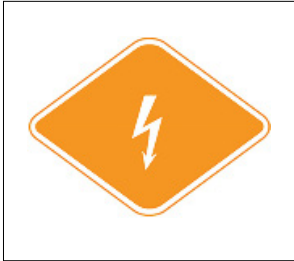

INFORMATION FOR FIRST AND SECOND RESPONDERS

EMERGENCY RESPONSE GUIDE



TESLA
MODEL Y
ELECTRIC



CONTENTS

0. Emergency Response Sheet	Page 1
1. Identification / recognition	Page 2
2. Immobilization / stabilization / lifting	Page 5
3. Disable direct hazards / safety regulations	Page 7
4. Access to the occupants	Page 12
5. Stored energy / liquids / gases / solids	Page 19
6. In case of fire	Page 23
7. In case of submersion	Page 25
8. Towing / transportation / storage	Page 26
9. Important additional information	Page 28
10. Explanation pictograms used	Page 29



TESLA MODEL Y

From 2020–Present

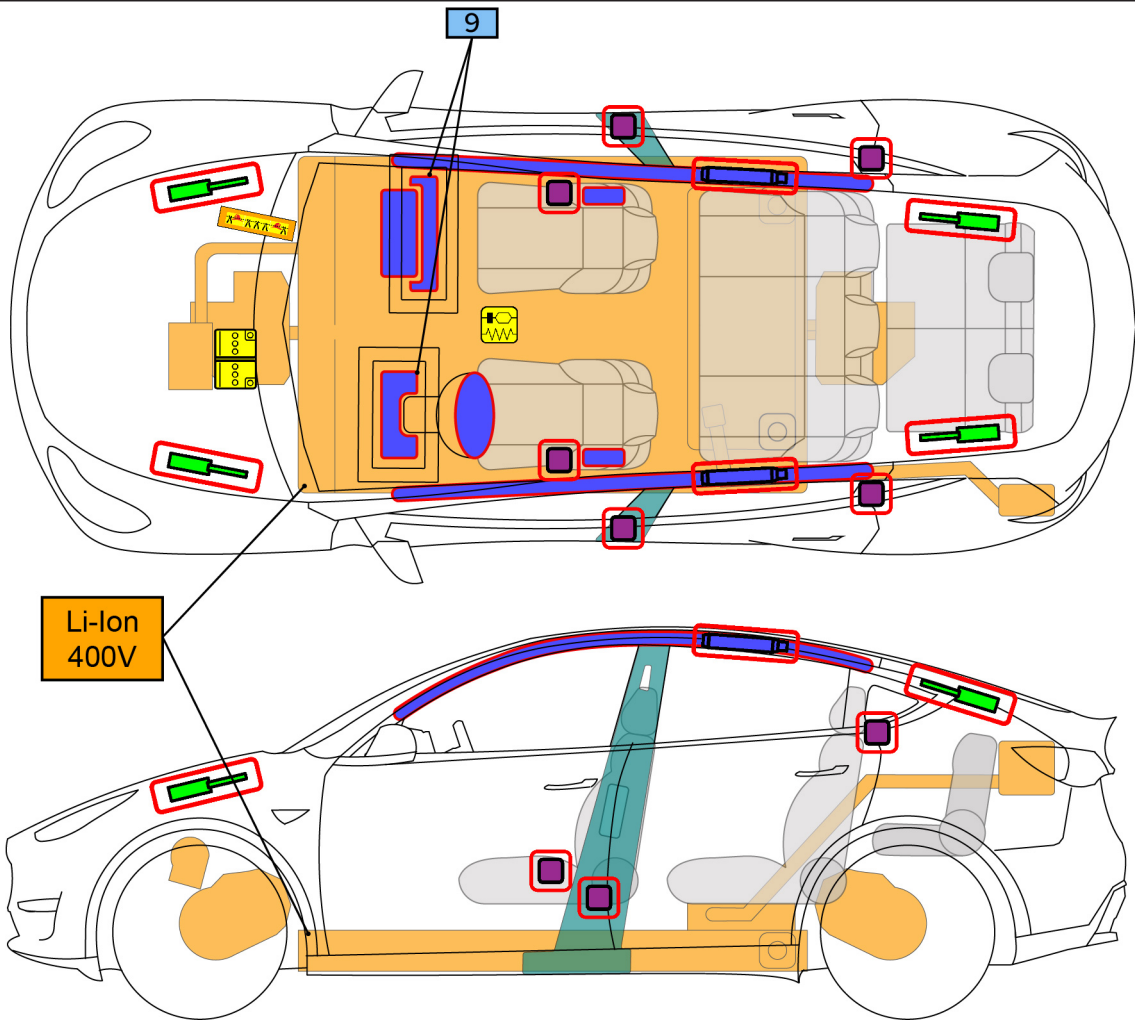

	Airbag		Stored gas inflator		Seatbelt pretensioner		SRS Control Unit		Pedestrian protection active system
	Automatic rollover protection system		Gas strut/pre-loaded spring		High strength zone		Zone requiring special attention		
	Battery low voltage		Ultra capacitor, low voltage		Fuel tank		Gas tank		Safety valve
	High voltage battery pack		High voltage power cable/component		High voltage disconnect		Fuse box disabling high voltage system		Ultra capacitor, high voltage

	Cable cut								
--	-----------	--	--	--	--	--	--	--	--

1. Identification / recognition



WARNING LACK OF ENGINE NOISE DOES NOT MEAN VEHICLE IS OFF. SILENT MOVEMENT OR INSTANT RESTART CAPABILITY EXISTS UNTIL VEHICLE IS FULLY SHUT DOWN. WEAR APPROPRIATE PERSONAL PROTECTIVE EQUIPMENT (PPE).

Badging and Door Handles

Model Y can be identified by its badges and uniquely shaped door handles. The model name does not appear on the rear of the vehicle.

NOTE: Model Y may have a “DUAL MOTOR” badge on the trunk to indicate that it is a dual motor configuration.

NOTE: The Tesla emblem indicates a fully electric vehicle.

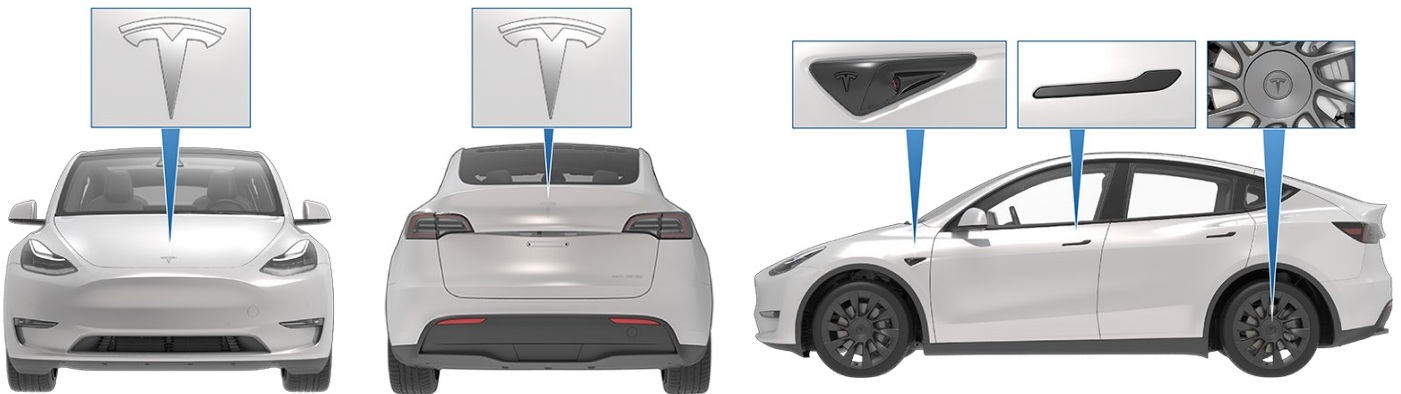

Vehicle Identification Number (VIN)

Model Y can be identified by its VIN. Locate the stamped plate on the top of the dashboard by looking through the driver's side of the windshield. Model Y is identified with a “Y” in the 4th alphanumeric position. The VIN can also be found on the driver's side door pillar, and on some vehicles, under the carpet behind the passenger seat.

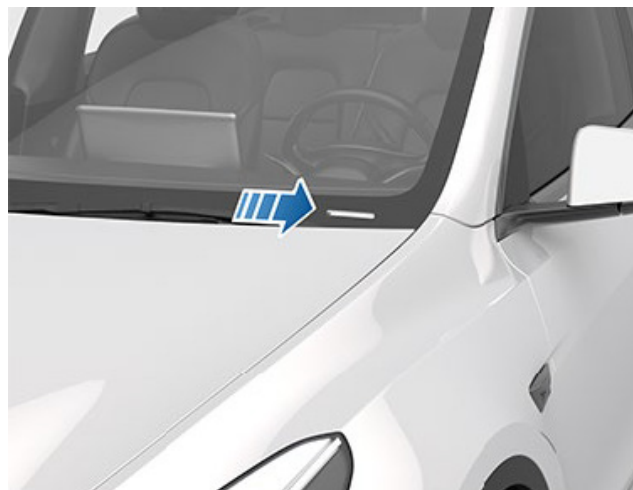

Touchscreen

Model Y can be identified by its 15 in (38 cm) touchscreen that is mounted in a “landscape” orientation. Model Y does not have an instrument cluster in front of the steering wheel.

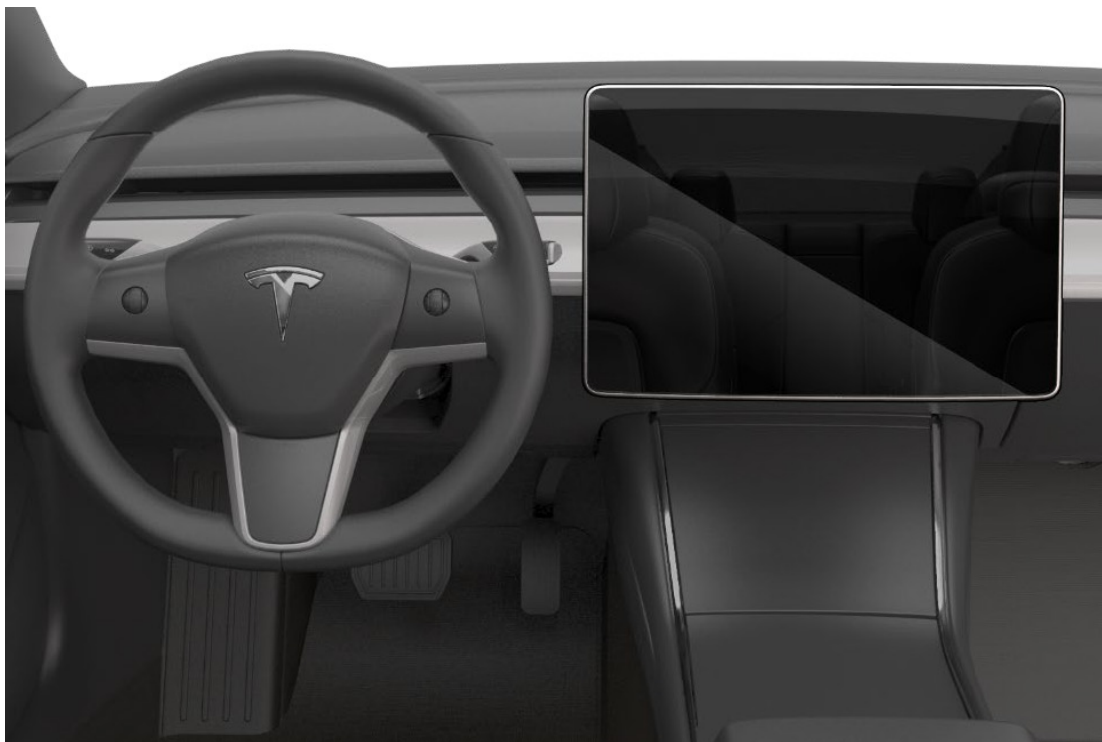

Refer to the Owner’s Manual for information on touchscreen operation. If vehicle airbags have deployed, 12V power may not be available and the touchscreen will not be operational. Trying to support 12V power on a vehicle that has been in an accident could lead to a possible 12V electrical fire. Tesla does not recommend attempting to reconnect 12V power.

Keys

Model Y supports 3 types of keys.

- **Authenticated phone** - A personal smartphone can be set up to communicate with Model Y using Bluetooth. If a smartphone is already paired to the vehicle, open the Tesla mobile app on the smartphone and navigate to CONTROLS to unlock or lock Model Y.
- **Key card** - Tap the Model Y key card on the driver's side door pillar to unlock or lock the vehicle, and once more on the center console to enable driving functionality.

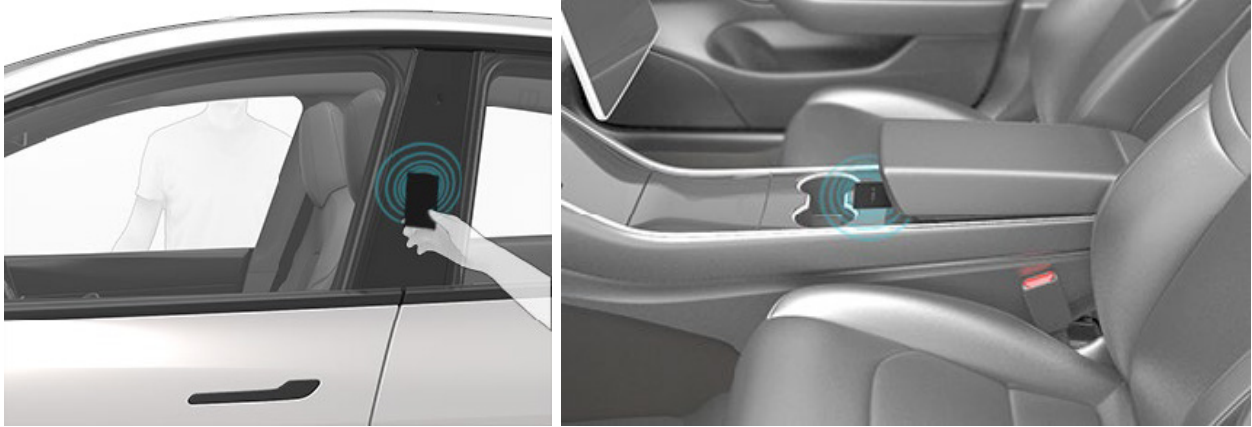

- **Key fob** - The key fob is shaped like a miniature Model Y. It allows you to press buttons to open the front and rear trunks and unlock, lock, and drive Model Y. Use the key buttons as shown below.



1. Front trunk - Double-click to unlatch the front trunk.
2. Lock/Unlock All - Single-click to lock doors and trunks (all doors and trunks must be closed). Double-click to unlock doors and trunks.
3. Rear trunk lid - Double-click to open or close the rear liftgate. Hold down for one to two seconds to open the charge port door.

2. Immobilization / stabilization / lifting

IMMOBILIZATION

1. Chock wheels

Model Y moves silently, so never assume it is powered off. Drivers can choose a setting that determines whether or not Model Y will “creep” when a drive gear is selected. If this setting is off, Model Y may not move unless the accelerator pedal is pressed, even if shifted into Drive or Reverse. However, never assume that Model Y will not move. Always chock the wheels.



WARNING Be careful to not damage the battery pack while stabilizing the vehicle.

2. Put vehicle into Park position

Model Y moves silently, so never assume it is powered off. Pressing the accelerator pedal even slightly can cause Model Y to accelerate quickly if the active gear is Drive or Reverse. To ensure that the parking brake is engaged, press the button on the end of the gear selector to shift into Park. Whenever Model Y is in Park, the parking brake is automatically engaged and the touchscreen shows the active gear as Park (P).



STABILIZATION / LIFTING POINTS

The high voltage battery is located under the floor pan. A large section of the undercarriage houses the high voltage battery. When lifting or stabilizing Model Y, only use the designated lift areas, as shown in green.



WARNING Be careful to not damage the battery pack while stabilizing / lifting the vehicle.





WARNING The vehicle should be lifted or manipulated only if first responders are trained and equipped at the technician level per National Fire Protection Association (NFPA) and are familiar with the vehicle's lifting points. Use caution to ensure you never come into contact with the high voltage battery or other high voltage components while lifting or manipulating the vehicle.

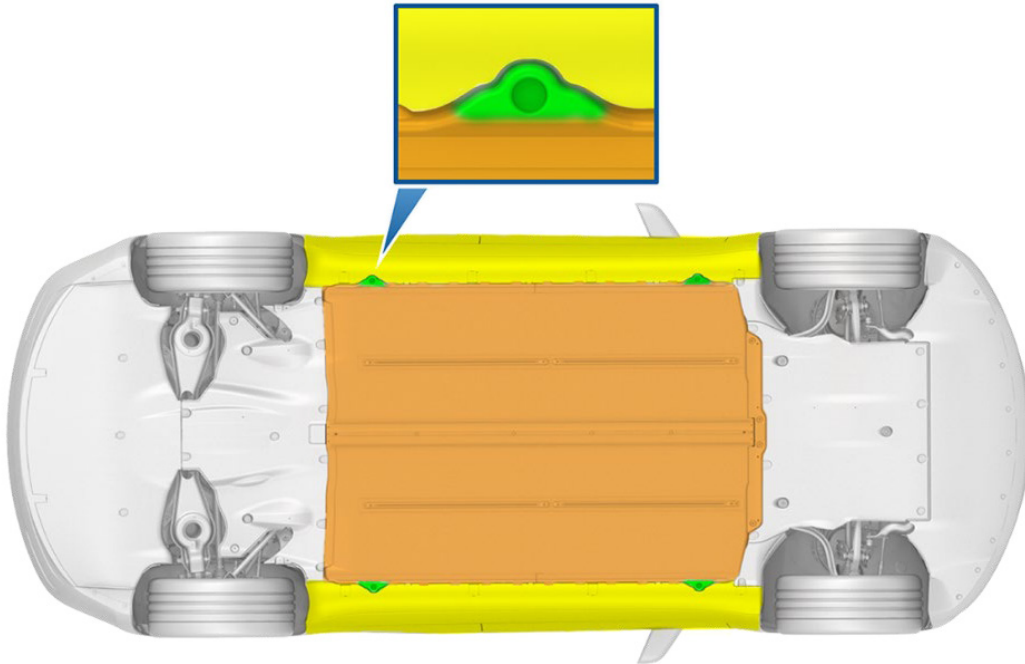

WARNING DO NOT USE THE HIGH VOLTAGE BATTERY TO LIFT OR STABILIZE MODEL Y.



	Appropriate lift areas
	Safe stabilization points for a Model Y resting on its side
	High voltage battery

3. Disable direct hazards / safety regulations

ACCESS

1. Open the hood (see chapter 4: Access to the Occupants).
2. Remove the access panel by pulling it upward to release the clips that hold it in place.

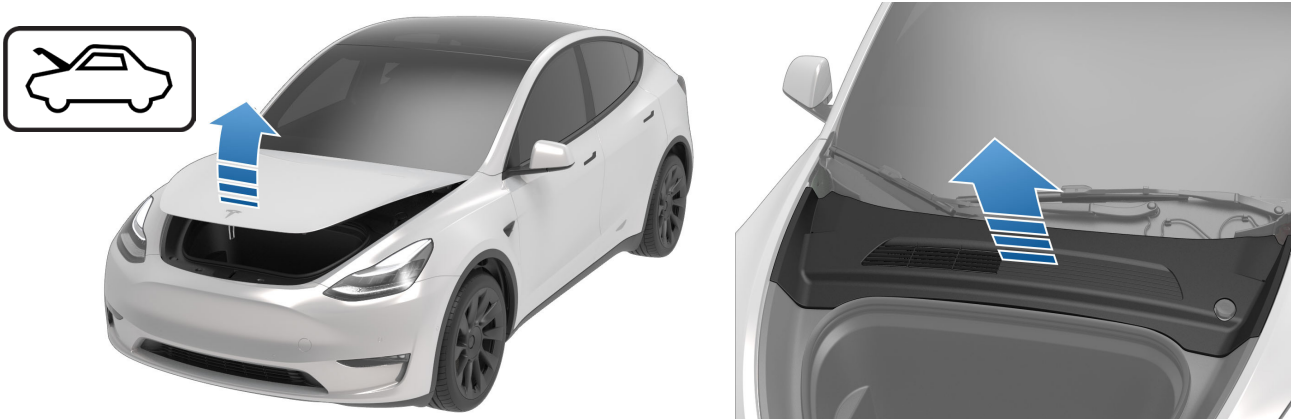

MAIN DISABLE METHOD

1. Double cut the first responder loop and then remove the cut section.
2. Disable the 12V battery.

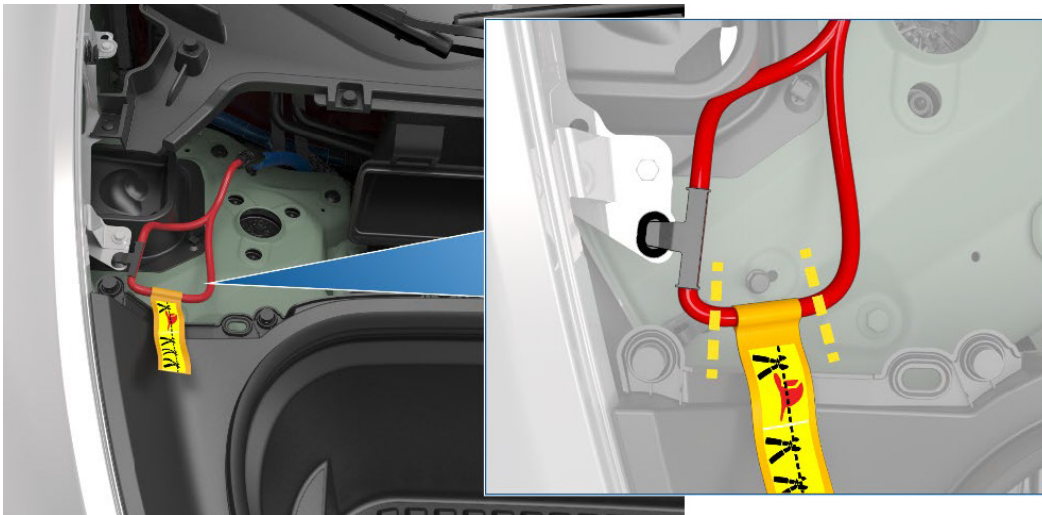

WARNING Not every high voltage component is labeled. Always wear appropriate PPE. Always double cut the first responder loop. Do not attempt to open the High Voltage (HV) battery.





Cable Cut

When cut, the First Responder Loop disables 12V power going to the airbag circuit. Cutting of the First Responder Loop also removes 12V power going to the high voltage contactors inside the high voltage battery pack. Cutting the first responder loop does not disable the 12V battery system. The 12V battery negative cable must be cut in order to disable the 12V battery system.

The First Responder Loop is located on the passenger-side of the vehicle for left-hand drive vehicles. The First Responder Loop remains in the same location for right-hand drive vehicles.

The high voltage contactors are like a light switch. When “open” or in the “off” position, the lights would be off in the room so the high voltage would be isolated to the battery pack. When “closed” or in the “on” position, the lights would be on in the room so the high voltage in the battery pack would be connected to the high voltage components. On Model Y vehicles, those high voltage components include the rear drive unit, the front drive unit, and the air conditioning compressor.

When the vehicle has been in an accident and the First Responder Loop has been cut, always treat the pack and the high voltage components as if they are live, because the pack will still have stored energy within the cells and it is not known if other high voltage components have been damaged. Treat every orange cable and battery pack as if there is high voltage in them. Never cut an orange high voltage cable or cut into the battery pack.

There is no way to instantaneously discharge the energy that is inside of the battery pack when a vehicle is in an accident. There is stored energy in battery cells. Caution must be used to not damage the battery pack in the case of vehicle extrication operations.

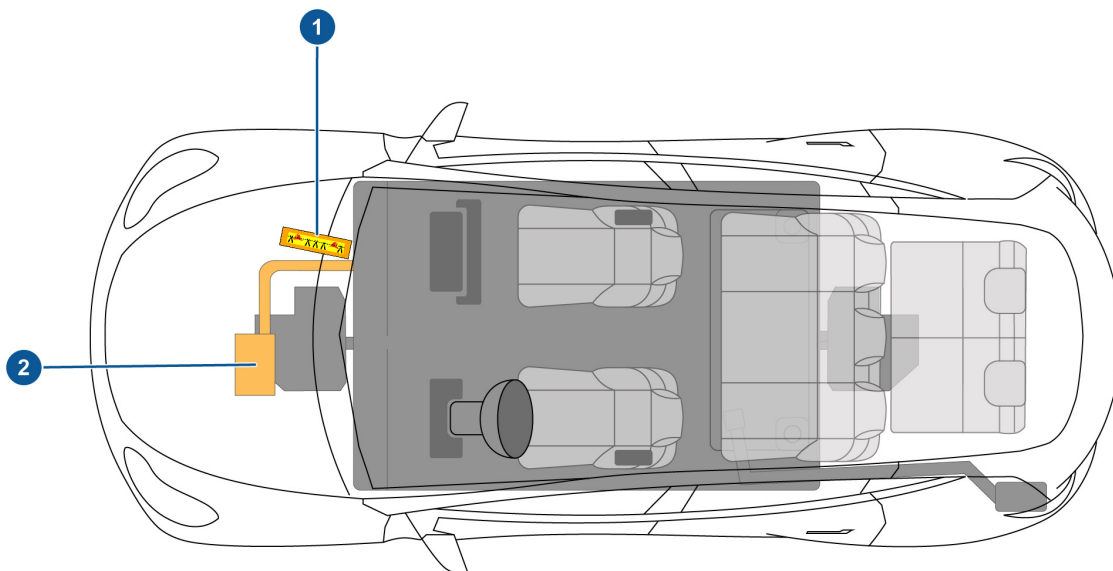

1. First Responder Cut Loop
2. 12V Battery

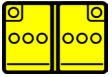

Battery Low-Voltage

When the vehicle's hood is opened, the 12V battery is accessible underneath the access panel next to the windshield. When necessary, the negative battery cable should be double cut to open the 12V battery circuit. Care should always be taken to not make contact with the positive and negative battery terminals when double cutting the negative battery cable.

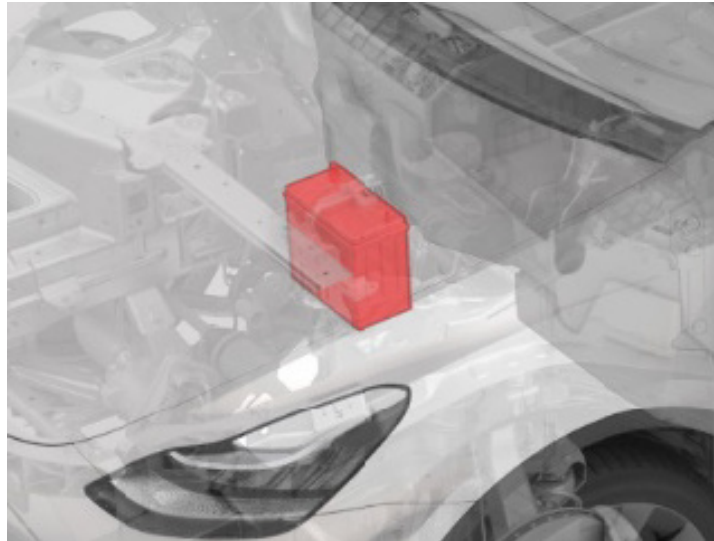

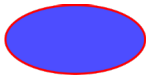

Airbags

Airbags are located in the approximate areas shown. Airbag warning information is printed on the sun visors.

When the airbags have been deployed by the Restraint Control Module (RCM), the pyro-technic fuse that deactivates the vehicle's high voltage system will be simultaneously triggered.

Model Y is designed to deactivate high voltage in all components and cables outside of the high voltage battery when an airbag is deployed. Care must be taken as to not cut any orange high voltage cables or try to gain access into the battery pack. Even though the high voltage system has shut down due to the airbags being deployed, it must always be assumed that there may be high voltage present in the high voltage cables and components. The battery cells within the battery pack will have stored energy and should not be compromised with rescue tools.

The First Responder Loop should be cut in order to open the 12V circuit that provides power to the airbags. See the First Responder Loop section for more details.

NOTE: Left Hand Drive, North American vehicle shown. On Right Hand Drive vehicles, the components are mirrored.

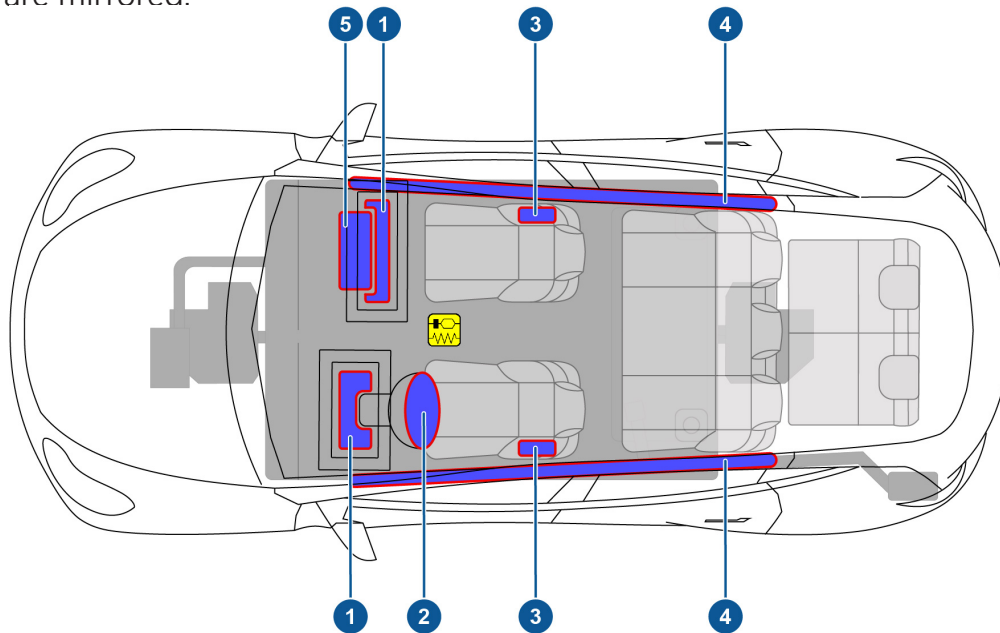

1. Knee airbags (North America and South Korea only)
2. Steering wheel airbag
3. Seat mounted side airbags
4. Curtain airbags
5. Passenger airbag



WARNING The RCM has an internal energy reserve which allows it to remain powered for some time after the 12V power is disconnected. The RCM will remain powered (from the vehicle) after it deploys any airbag or pre-tensioner. Do not touch the RCM within 10 seconds of an airbag or pre-tensioner deployment.



Stored Gas Inflators

The stored gas inflators, outlined in red, are located near the roof and towards the rear of the vehicle.

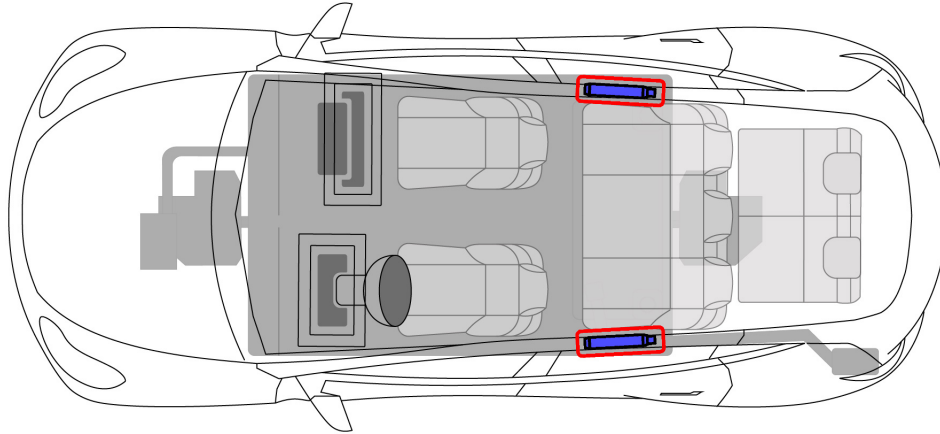

WARNING Rescuers should never cut or crush inflation cylinders. Cutting or compressing cylinders causes catastrophic failure, leading to injury or death.



WARNING The RCM has a backup power supply with a discharge time of approximately 10 seconds. Do not touch the RCM within 10 seconds of an airbag or pre-tensioner deployment.



Seatbelt Pre-Tensioners

The seat belt pre-tensioners, outlined in red, are located at the bottom of the B-pillars and outboard of the 2nd row seats.

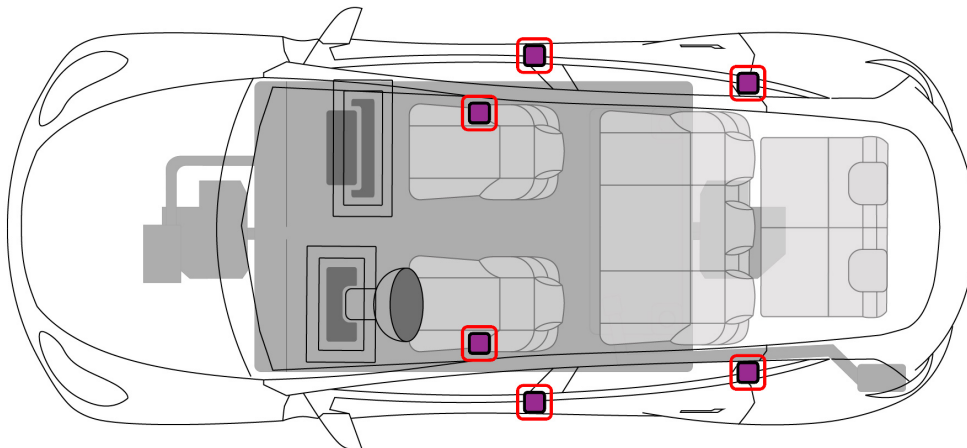

WARNING Electrical and mechanical releases may be compromised after a collision.



4. Access to the occupants

NOTE: The seats and steering wheel are electrically powered and may not function after a collision.

NOTE: After a collision, the doors and liftgate may not unlock from the outside. Extrication may be required.

Opening Doors from the Outside with Power

To open the Model Y doors from the outside, press the wide part of a door handle inwards and then pull the door open.

NOTE: If the door handles do not function, open a front door manually by reaching inside the window and using the mechanical release handle. See Opening Front Doors from Inside without Power.



Opening Doors from Inside with Power

To open the Model Y doors from the inside with 12V power enabled, press the button located near the door panel.



Opening Front Doors from Inside without Power

To open the Model Y front doors from the inside without 12V power, lift the mechanical release handle located near the window switches.

It is important to know that in any vehicle collision with damage to the driver or passenger front door, the mechanical door release may not operate as designed. It is also important to remember that every vehicle accident is different and may require extrication operations to gain access to the vehicle's cabin.

NOTE: Only the front doors are equipped with a mechanical release handle.



Opening the Liftgate with 12V Power

Use one of the following methods to open the liftgate:

1. Touch the associated OPEN button on the touchscreen for the liftgate.
2. Press the switch located under the exterior handle on the liftgate.





Moving the Front Seats with Power

Model Y has electrically powered seats that move with buttons located on the side of the seat closest to the door. The buttons operate only when 12V power is enabled.



1. Moves seat forward/backward and adjust the seat's height and tilt angle up/down.
2. Adjusts rest.
3. Adjusts lumbar support.

NOTE: If 12V power is not available, the front seats cannot be moved.

NOTE: When performing occupant extrication, always check for occupants in the rear seating area. It is possible the vehicle will have third row occupants depending on the vehicle's seating configuration.



Opening the Hood with Power

Model Y does not have a traditional internal combustion engine. Therefore, the area that would normally house the engine is used as additional storage space. Tesla calls this area the "Front Trunk".

To open the hood with 12V power enabled, touch the associated OPEN button on the touchscreen.



Opening the Hood using External 12V Power Supply

This method will not open the front trunk if Model Y is locked and has 12V power. Use an external power supply, such as a jumper box, for the following:

1. Locate an external 12V power supply.
2. Release the tow eye cover by pressing firmly on the top right perimeter of the cover until it pivots inward, then pulling the raised section toward you.

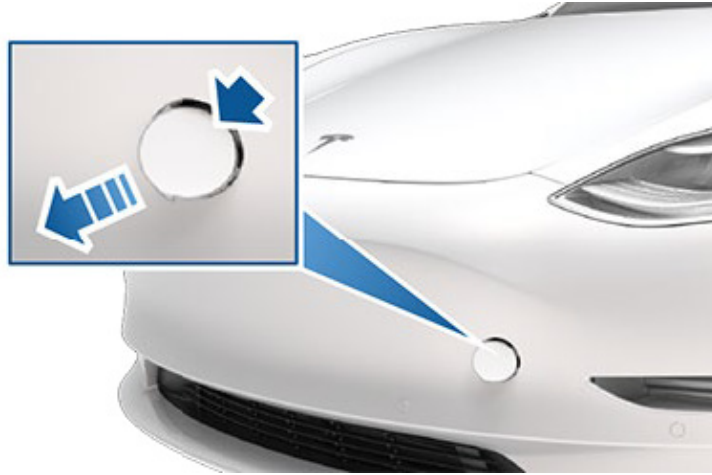

3. Pull the two wires out of the tow eye opening to expose the vehicle-side terminals.

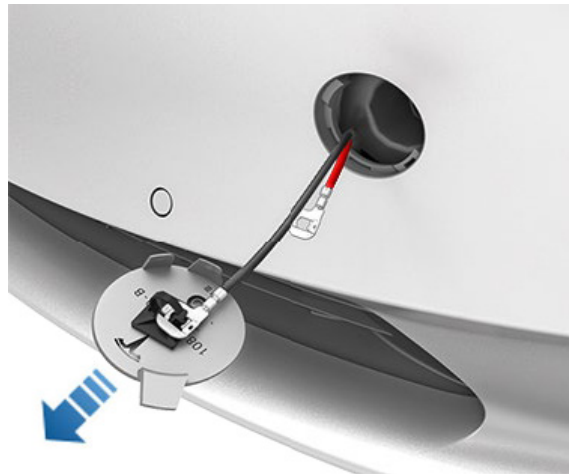

4. Connect the external 12V power supply's red positive (+) cable to the red positive (+) vehicle-side terminal.
5. Connect the external 12V power supply's black negative (-) cable to the black negative (-) vehicle-side terminal.

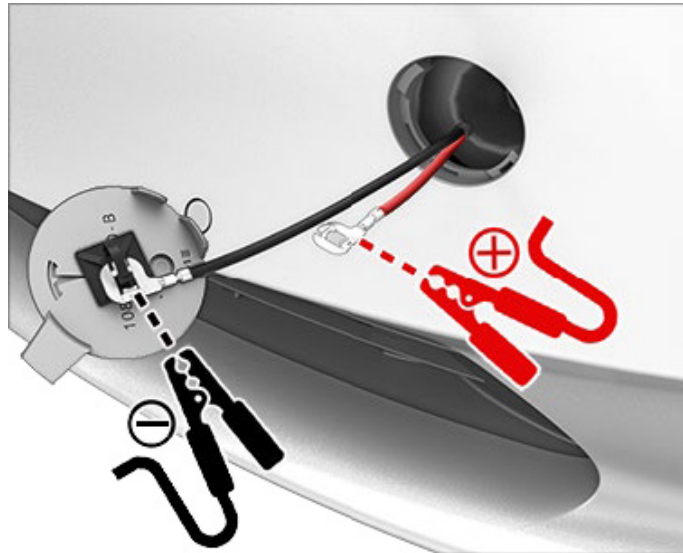

6. Turn on the external power supply (refer to the external power supply manufacturer's instructions). The hood latches are immediately released and you can now open the hood to access the front trunk area.
7. Disconnect both external power supply cables, beginning with the black negative (-) cable.



High Strength Zone

Model Y is reinforced to protect occupants in a collision. Suitable tools must be used to cut or crush these areas. Reinforcements are shown in teal below.

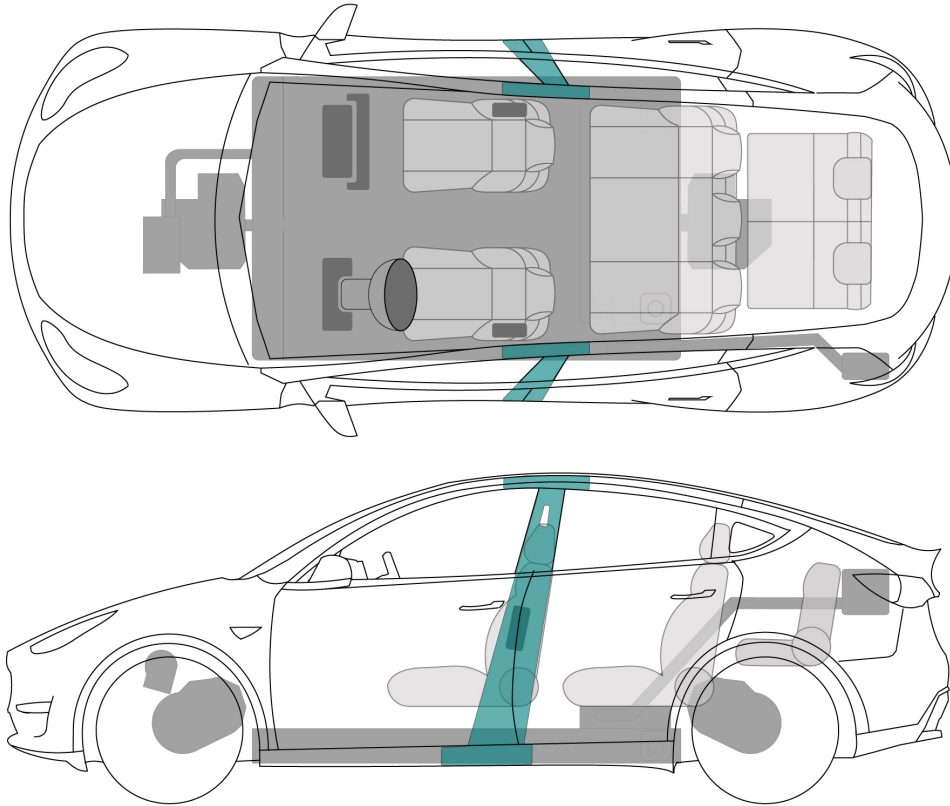

The B-pillar of Model Y is constructed of ultra-high-strength reinforced steel. The vehicle's doors are made of aluminum. All other structural body components are made up of various strengths of steel.

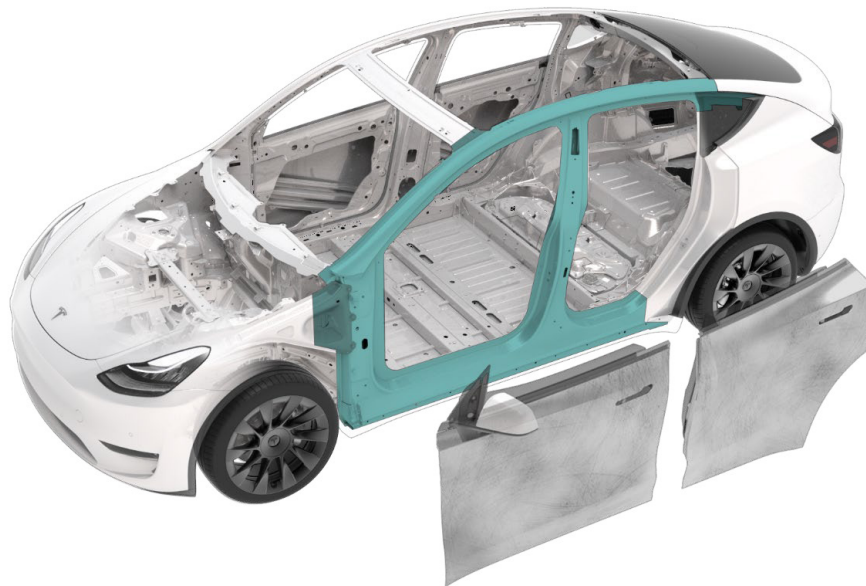



WARNING Always use appropriate tools, such as a hydraulic cutter, and always wear appropriate PPE when cutting Model Y. Failure to follow these instructions can result in serious injury or death.



WARNING Regardless of the disabling procedure you use, ALWAYS ASSUME THAT ALL HIGH VOLTAGE COMPONENTS ARE ENERGIZED! Cutting, crushing, or touching high voltage components can result in serious injury or death.

No-Cut Zones

Model Y has areas that are defined as “no-cut zones” due to the presence of high voltage, gas struts, SRS components, or other hazards. Never cut or crush in these areas. Doing so could result in serious injury or death. The “no-cut zones” are shown in pink.

NOTE: The following image shows a Dual Motor vehicle. Vehicles without a front drive unit are similar.

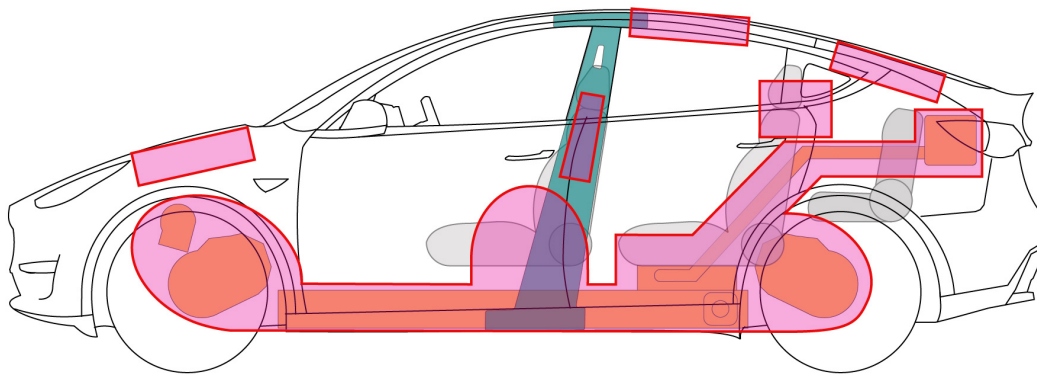



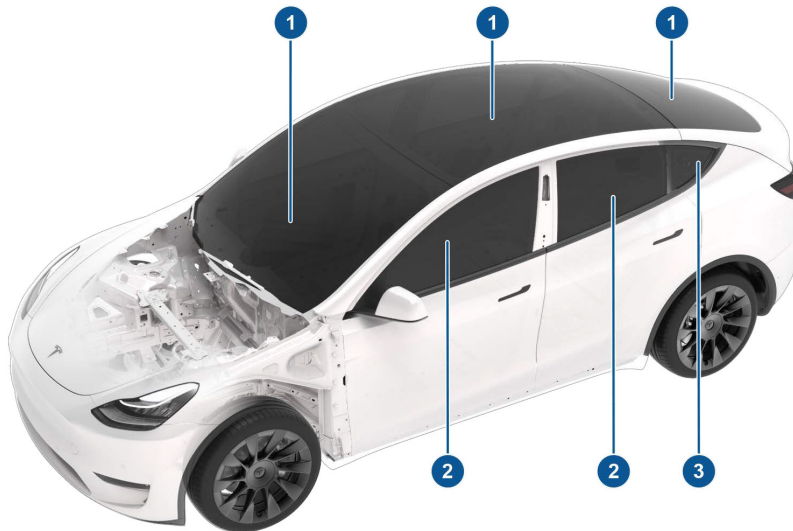

Windows

The windshield, roof glass, and rear liftgate glass on Model Y are made of laminated safety glass. The side windows can be either tempered or laminated glass.

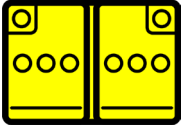

1. Laminated safety glass
2. Tempered or laminated safety glass
3. Tempered safety glass

5. Stored energy / liquids / gases / solids

		12V
		400V



WARNING The cells in the HV battery are sealed and there is not enough electrolyte to create a pool of liquid. Clear liquid is likely water. The coolant is blue.



NOTE: The following images show a Dual Motor vehicle. Vehicles without a front drive unit are similar.



High Voltage Components

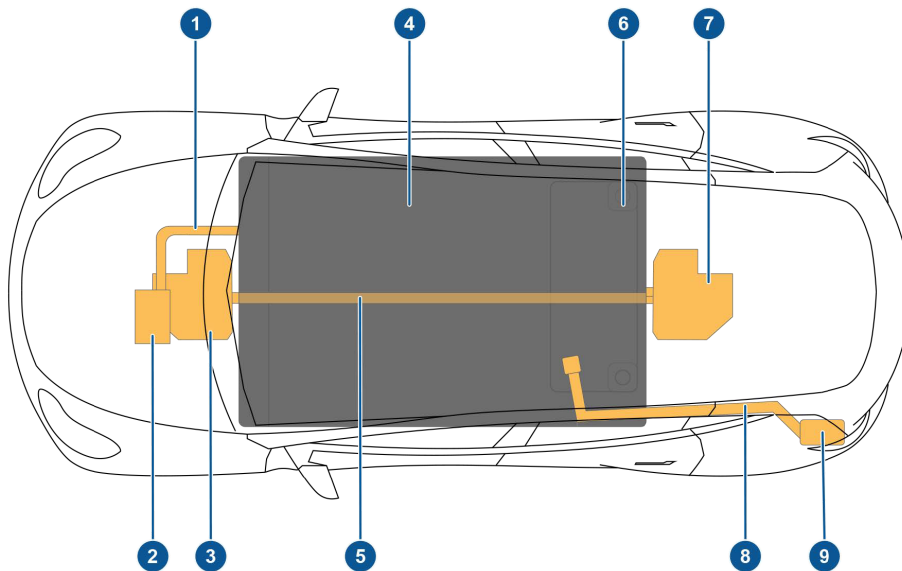

1. High Voltage Cabling
2. Air Conditioning Compressor
3. Front Motor (Dual Motor vehicles only)
4. High Voltage Battery
5. High Voltage Cabling
6. High Voltage Battery Service Panel
7. Rear Motor
8. High Voltage Busbars
9. Charge Port



High Voltage Battery Pack

Model Y is equipped with a floor-mounted 400V lithium-ion high voltage battery. The battery is made up of many cells that are liquid cooled with coolant. The coolant will appear blue in color and may leak from the battery pack if the pack has been compromised during a vehicle collision. The battery cells will have stored energy within them. Never breach the high voltage battery when lifting from under the vehicle. When using rescue tools, pay special attention to ensure that you do not breach the floor pan. Refer to Chapter 2: Lift Areas for instructions on how to properly lift the vehicle.

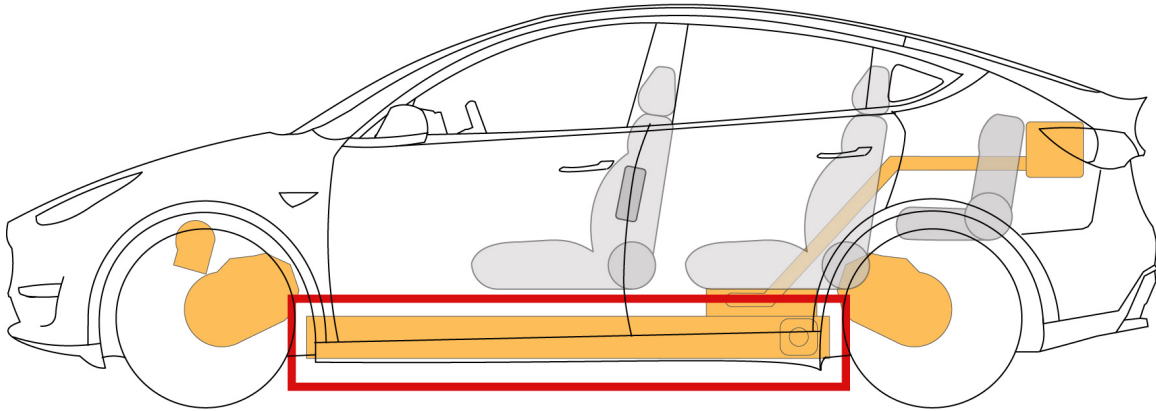

Pushing on the Floor Pan

The high voltage battery is located below the floor pan. Never push on the floor pan itself inside of Model Y. Doing so can breach the high voltage battery or damage the high voltage cables, which can cause serious injury or death. At no time should the high voltage battery pack be compromised with rescue tools.

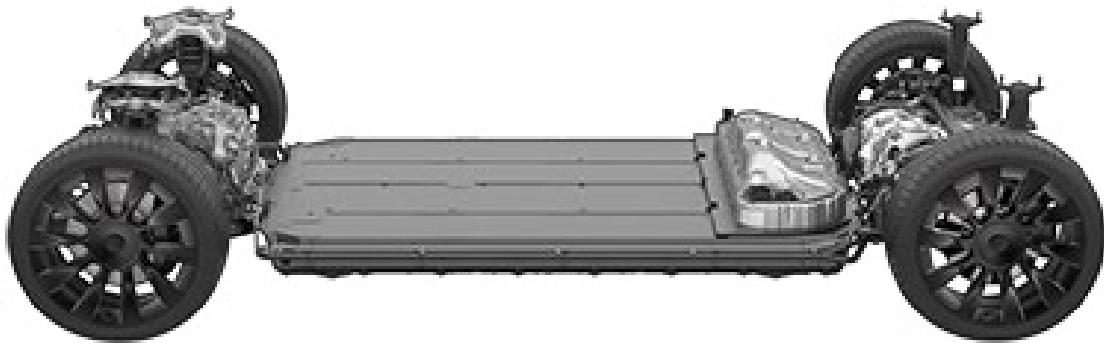



High Voltage Power Cable / Component

High voltage cables are shown in orange. There are high voltage cables that run the length of the battery pack on the bottom side through an extrusion providing protection. Do not compromise these high voltage cables with rescue tools. At no time should any high voltage cables be compromised with rescue tools. The assumption should be made that at all times there may be high voltage present in the Orange High Voltage Cables.

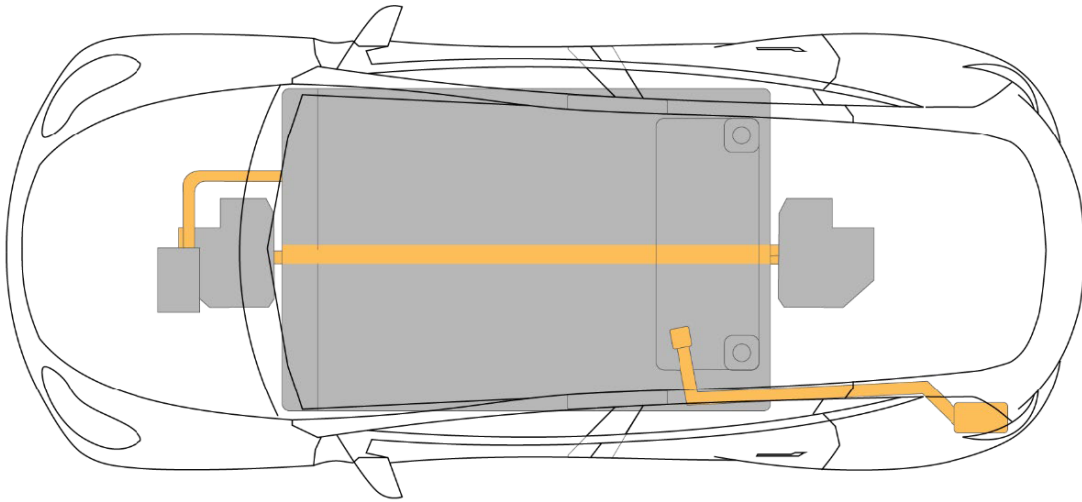

Drive Units

The rear drive unit is located between the rear wheels, and the front drive unit (if equipped-Dual Motor vehicles only) is located between the front wheels. The drive inverter is located within the drive unit. The drive units convert Direct Current (DC) from the high voltage battery into Alternating Current (AC) that the drive units use to power the wheels.

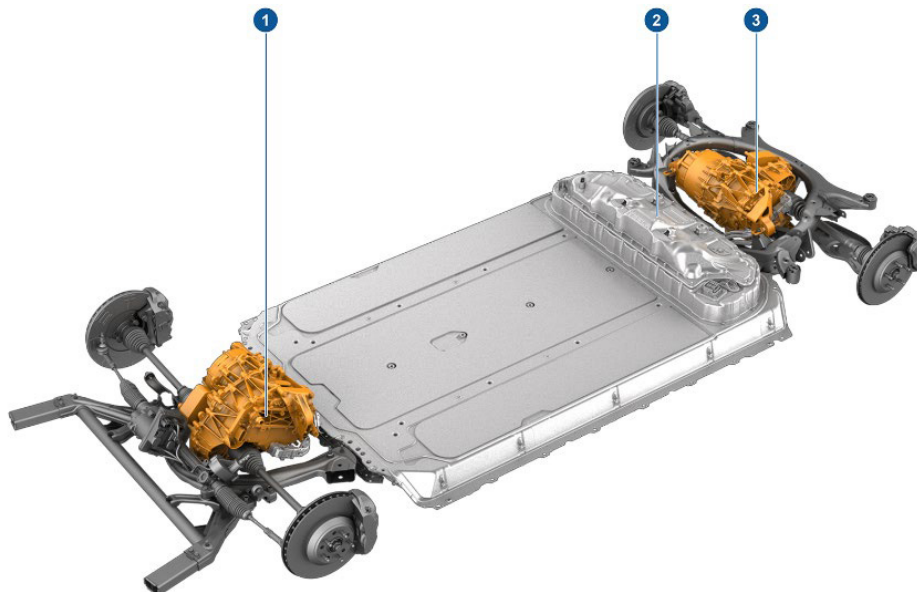

1. Front Drive Unit
2. DC-DC within the battery enclosure
3. Rear Drive Unit

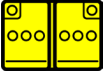

Battery Low-Voltage

In addition to the high voltage system, Model Y has a low voltage electrical system. Its 12V battery operates the restraint system, airbags, windows, door locks, touchscreen, and interior and exterior lights. The high voltage system charges the 12V battery, and the 12V battery supplies power to the high voltage contactors, allowing high voltage current to flow into and out of the high voltage battery. The 12V battery, outlined in red, is located under the hood and the plastic access panel.

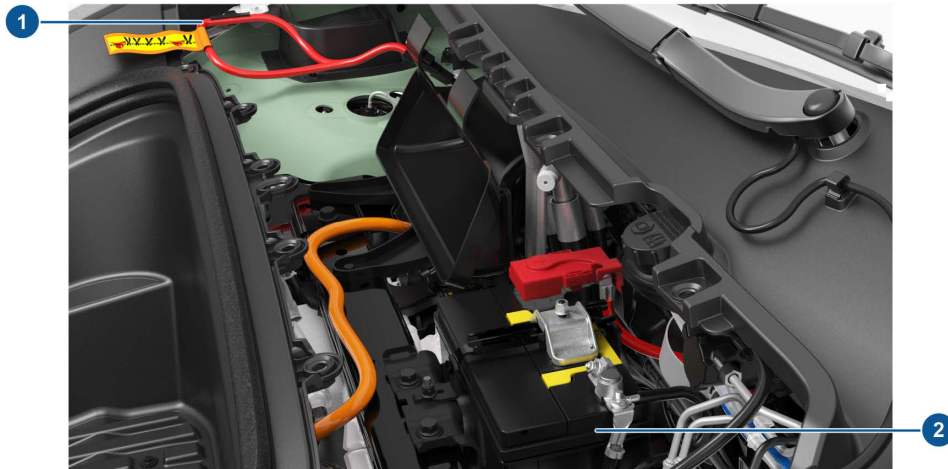
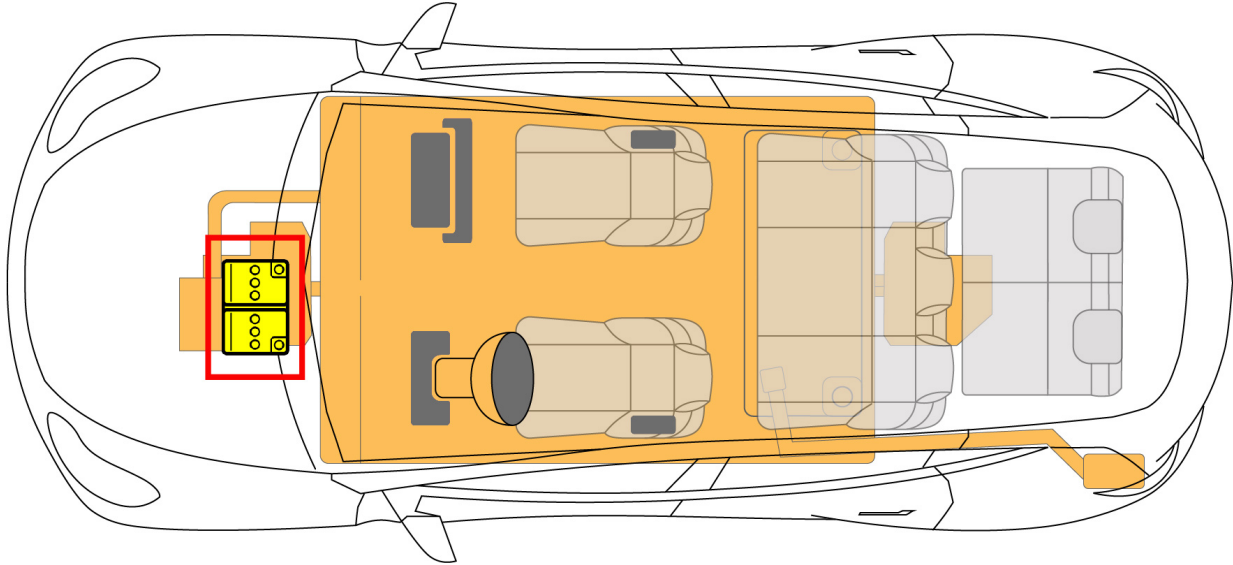

1. First Responder Cut Loop
2. 12V Battery

6. In case of fire

Firefighting



USE WATER TO FIGHT A HIGH VOLTAGE BATTERY FIRE. If the battery catches fire, is exposed to high heat, or is generating heat or gases, use large amounts of water to cool the battery. It can take between approximately 3,000-8,000 gallons (11,356-30,283 liters) of water, applied directly to the battery, to fully extinguish and cool down a battery fire; always establish or request additional water supply early. If water is not immediately available, use CO₂, dry chemicals, or another typical fire-extinguishing agent to fight the fire until water is available.

NOTE: Tesla does not recommend the use of foam on electric vehicles.

Apply water directly to the battery. If safety permits, lift or tilt the vehicle for more direct access to the battery (see chapter 2). Water may be applied from a safe distance ONLY if a natural opening (such as a vent or opening from a collision) already exists. Do not open the battery for the purpose of cooling it.

Tesla does not recommend placing the vehicle in a large container full of water. The use of a Thermal Imagery Camera or Infrared (TIC or IR) is recommended to monitor battery temperatures during the cooling process. Continue to use water until the battery has reached ambient temperatures or below, indicated by the thermal imagery camera. When utilizing a thermal imaging camera, allow enough time, once the application of water has stopped, to allow for heat within the battery to transfer to the battery enclosure.

Extinguish small fires that do not involve the high voltage battery using typical vehicle firefighting procedures.

During fire extinguishing, do not make contact with any high voltage components. Always use insulated tools for fire extinguishing.



Heat and flames can compromise airbag inflators, stored gas inflation cylinders, gas struts, and other components which can result in unexpected excessive heat, which can cause inflation cylinder explosion. Perform an adequate knock down before entering a hot zone.



Battery fires can take up to 24 hours to fully cool. After suppression and smoke has visibly subsided, a thermal imaging camera can be used to actively measure the temperature of the high voltage battery and monitor the trend of heating or cooling. There must be no fire, smoke, audible popping/hissing, or heating present in the high voltage battery for at least 45 minutes before the vehicle can be released to second responders (such as law enforcement, vehicle transporters, etc.). The battery must be completely cooled before releasing the vehicle to second responders or otherwise leaving the incident.

Always advise second responders that there is a risk of battery re-ignition. Second responders should be advised to position the vehicle to drain excess water out of the vehicle by tilting or repositioning it. This operation can assist in mitigating possible re-ignition.

Due to potential re-ignition, a Model Y that has been involved in a submersion, fire, or a collision that has compromised the high voltage battery should be stored in an open area at least 50 feet (15 m) from any exposure.



WARNING During all firefighting activities, consider the vehicle energized. Always wear full PPE including a Self-Contained Breathing Apparatus (SCBA).

High-Voltage Battery – Fire Damage



Similar to conventional and other electric and hybrid vehicles, a burning battery releases super-heated gases and toxic vapors. This release may include volatile organic compounds, hydrogen gas, carbon dioxide, carbon monoxide, soot, particulates containing oxides of nickel, aluminum, lithium, copper, cobalt, and hydrogen fluoride. Responders should always protect themselves with full PPE, including a SCBA, and take appropriate measures to protect civilians downwind from the incident.

The high voltage battery consists of lithium-ion cells. If damaged, only a small amount of fluid can leak.

The high voltage battery and drive unit(s) are liquid cooled with a typical glycol-based automotive coolant. If damaged, this blue coolant can leak out of the high voltage battery.



A damaged high voltage battery can create rapid heating of the battery cells. If you notice smoke, steam, or audible popping or hissing coming from the high voltage battery, assume that it is heated and take appropriate action as described above.

7. In case of submersion

Treat a submerged Model Y like any other submerged vehicle. The body of Model Y does not present a greater risk of shock because it is in water. However, handle any submerged vehicle while wearing the appropriate PPE for water rescue. Remove the vehicle from the water and continue with normal high voltage disabling.

Vehicles that have been submerged in water should be handled with greater caution due to the potential risk of a high voltage electrical battery fire. First responders should be prepared to respond to a potential fire risk. Raise the front of the vehicle to allow water to drain out of the vehicle and the high voltage battery pack. After the vehicle is removed from the water, continue normal disabling procedures as outlined in Chapter 3.

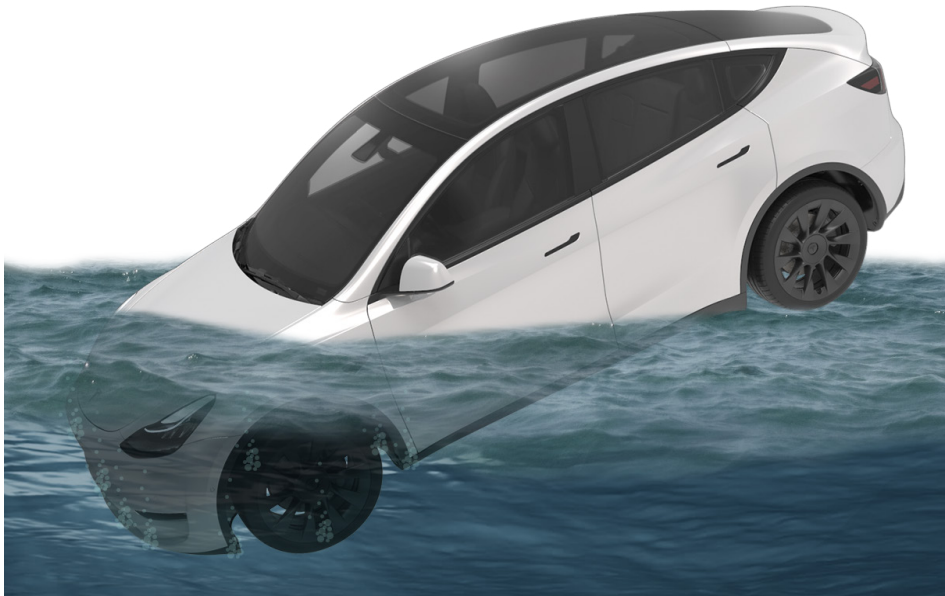

8. Towing / transportation / storage

The rear motor in the Model Y can generate power when the wheels spin. Always transport with all four tires off of the ground. Ensure that the tires are unable to spin at any time during transport.



WARNING NEVER TRANSPORT THE VEHICLE WITH THE TIRES IN A POSITION WHERE THEY CAN SPIN. DOING SO CAN LEAD TO SIGNIFICANT DAMAGE AND OVERHEATING. IN RARE CASES EXTREME OVERHEATING MAY CAUSE THE SURROUNDING COMPONENTS TO IGNITE.



WARNING POSSIBLE BATTERY RE-IGNITION! AFTER A FIRE INCIDENT, STORE OUTSIDE AT A SAFE DISTANCE (50 FT/15 M) FROM OTHER VEHICLES AND STRUCTURES!



A roll-back truck or comparable transport vehicle is the recommended method of transport. The vehicle can face either direction when using a flatbed. If the vehicle must be transported without a roll-back truck, then wheel lifts and dollies must be used to ensure that all four wheels are off of the ground. This method must not exceed the manufacturer speed rating of the dollies. With this method, Tesla recommends the vehicle faces forward so that the front wheels are lifted and the rear wheels are on dollies.

NOTE: The tires are allowed to rotate slowly (under 3 mph or 5 km/h) and for a very short distance (less than 30 feet or 10 meters) only when Transport Mode is enabled while the vehicle is being winched onto a flatbed truck or pulled out of a parking space for repositioning. Exceeding these boundaries can lead to significant damage and overheating that is not covered by the warranty.

NOTE: Enable Transport Mode on the vehicle's touchscreen before winching the vehicle onto a flatbed truck. If Transport Mode is not available or the touchscreen is not accessible, self-loading dollies or tire skates must be used to load the vehicle into the approved transportation position. Tesla is not responsible for any damage caused by or during transport of the vehicle, including personal property damage or damage caused by using self-loading dollies or tire skates.



WARNING The vehicle is equipped with high voltage components that may be compromised as a result of a collision. Before transporting, it is important to assume these components are energized. Always follow high voltage safety precautions (wearing personal protective equipment, etc.) until emergency response professionals have evaluated the vehicle and can accurately confirm that all high voltage systems are no longer energized. Failure to do so may result in serious injury.

Pushing the Vehicle



WARNING The following instructions are intended to be used when only moving Model Y a very short distance to improve traffic safety. Refer to the Owner's Manual on the touchscreen or the Roadside Assistance Guide in the glovebox for more instructions on how to transport Model Y. Damage caused by transporting the vehicle is not covered by the warranty.



WARNING Pushing Model Y when it is not in Neutral or Transport Mode can result in overheating the rear motor and potential risk of shock if electrical components are exposed, even if the first responder loop has been cut.

In situations where there is minimal risk of fire or high voltage exposure (for example, the vehicle does not accelerate after coming to a stop at an intersection) and 12V power is present, Model Y can be quickly pushed in order to clear the roadway. If a driver is present, simply shift Model Y into Neutral and then push the vehicle. If a driver is not present, Model Y may automatically shift into Park when it detects the driver leaving the vehicle (even if it has previously been shifted into Neutral).

To keep Model Y in Neutral (which disengages the parking brake and allows the vehicle to be pushed) without a driver present, use the touchscreen to activate Transport Mode:

1. Ensure Model Y is in Park.
2. Press and hold the brake pedal, then on the touchscreen touch Controls > Service > Towing.
3. Hold the Transport Mode button until it turns blue. Model Y is now free-rolling and can slowly be rolled (no faster than walking speed) or winched.

To cancel Transport Mode, shift Model Y into Park.

NOTE: Model Y must detect a key nearby and 12V power is required for Transport Mode to activate.

NOTE: Transport Mode automatically cancels and the parking brake is applied if Model Y is rolled faster than 5 mph (8 km/h) or 12V power becomes low or absent. Model Y sounds its horn if Transport Mode is about to cancel.

NOTE: If Model Y cannot detect the key (an authenticated smartphone or key), the Transport Mode button is grayed out and Transport Mode cannot be enabled. Call Tesla Roadside Assistance.

NOTE: The touchscreen is unresponsive if Model Y has no 12V power. Use an external 12V power to open the hood and jump start the vehicle's auxiliary 12V battery. Refer to the Roadside Assistance Guide in the glovebox (Touch Controls > Glovebox) or call Tesla Roadside Assistance for instructions.

9. Important additional information

This document contains important instructions and warnings that must be followed when handling Model Y in an emergency situation.

NOTE: Images in this document show a Left-Hand Drive (LHD), North American vehicle. Unless otherwise noted, Right-Hand Drive (RHD) vehicles are mirrored.

NOTE: Model Y is equipped with knee airbags in North America and South Korea only.



WARNING Always use appropriate rescue tools and always wear appropriate PPE. Failure to follow these instructions can result in serious injury or death.



WARNING Regardless of the disabling procedure you use, ALWAYS ASSUME THAT ALL HIGH VOLTAGE COMPONENTS ARE ENERGIZED! Cutting, crushing, or touching high voltage components can result in serious injury or death.



WARNING After deactivation, the high voltage circuit requires 2 minutes to de-energize.



WARNING The RCM has a backup power supply with a discharge time of approximately 10 seconds. Do not touch the RCM within 10 seconds of an airbag or pre-tensioner deployment.



WARNING Handling a submerged vehicle without appropriate PPE for water rescue can result in serious injury or death.



WARNING When fire is involved, consider the entire vehicle energized. Always wear full PPE, including a SCBA.



WARNING When cutting the first responder loop, double cut the loop to remove an entire section. This eliminates the risk of the cut wires accidentally reconnecting.



WARNING When using the high voltage shut down methods recommended by this document, high voltage power is isolated to the battery. The high voltage battery is always energized.



WARNING Never transport the Model Y with rear wheels on the ground. Doing so can lead to significant damage and overheating. In rare cases, extreme overheating may cause the surrounding components to ignite.

Contact Us











First Responders and Second Responders with emergencies, call Tesla Roadside Assistance. Refer to <https://www.tesla.com/support/roadside-assistance> for the applicable number.

The Model Y Owner's Manual and first responder information can be found at <https://www.tesla.com/firstresponders>. First responders and training officers who have questions, contact firstrespondersafety@tesla.com.

Airbags

	<p>Knee airbags are only installed in North America and South Korea.</p>
---	--

10. Explanation pictograms used

	<p>In some working environments, the Infrared (IR) device is referred to as a Thermal Imaging Camera (TIC).</p>
	<p>Refers to the hood of a vehicle and follows with detailed procedure for opening the hood both with and without power available.</p>
	<p>Refers to the liftgate of a vehicle and follows with detailed procedure for opening the liftgate with power.</p>
	<p>Electricity warning</p>
	<p>Flammable</p>
	<p>Explosive</p>
	<p>Corrosive substances present</p>
	<p>Hazardous to human health</p>
	<p>Acute toxicity</p>
	<p>Contains gases under pressure</p>
	<p>Use water to extinguish</p>